

D25F1

2.5 m³/h - 1%
11 GPM - 1:100
0.3 - 6 bar
4.3 - 85 psi

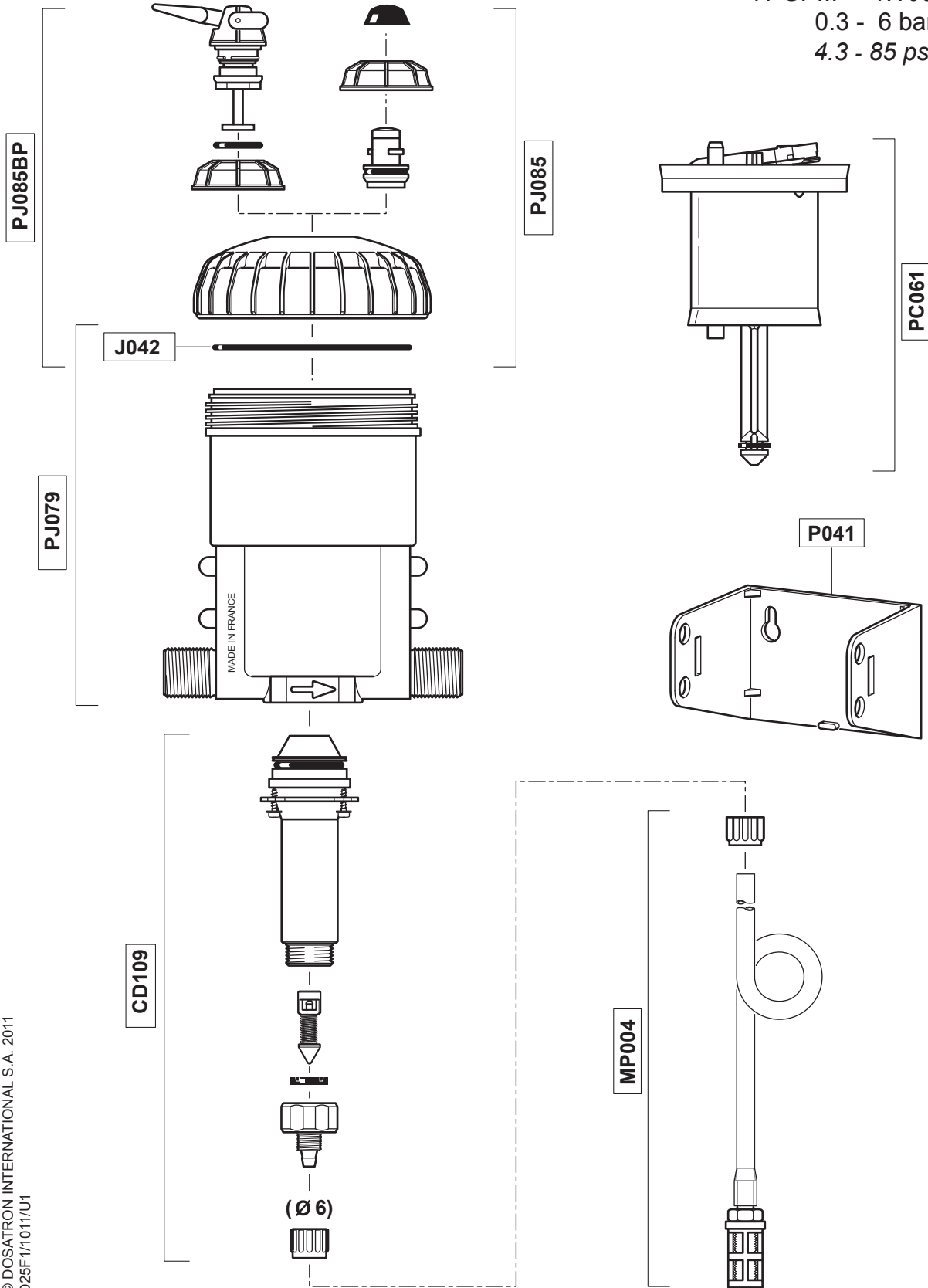

D25F1

2.5 m³/h - 1%
11 GPM - 1:100
0.3 - 6 bar
4.3 - 85 psi

